

ecorail®

KORKULUK SİSTEMLERİ / RAILING SYSTEMS

PRATİK VE EKONOMİK KORKULUK SİSTEMLERİ
PRATIC & ECONOMIC RAILING SYSTEMS

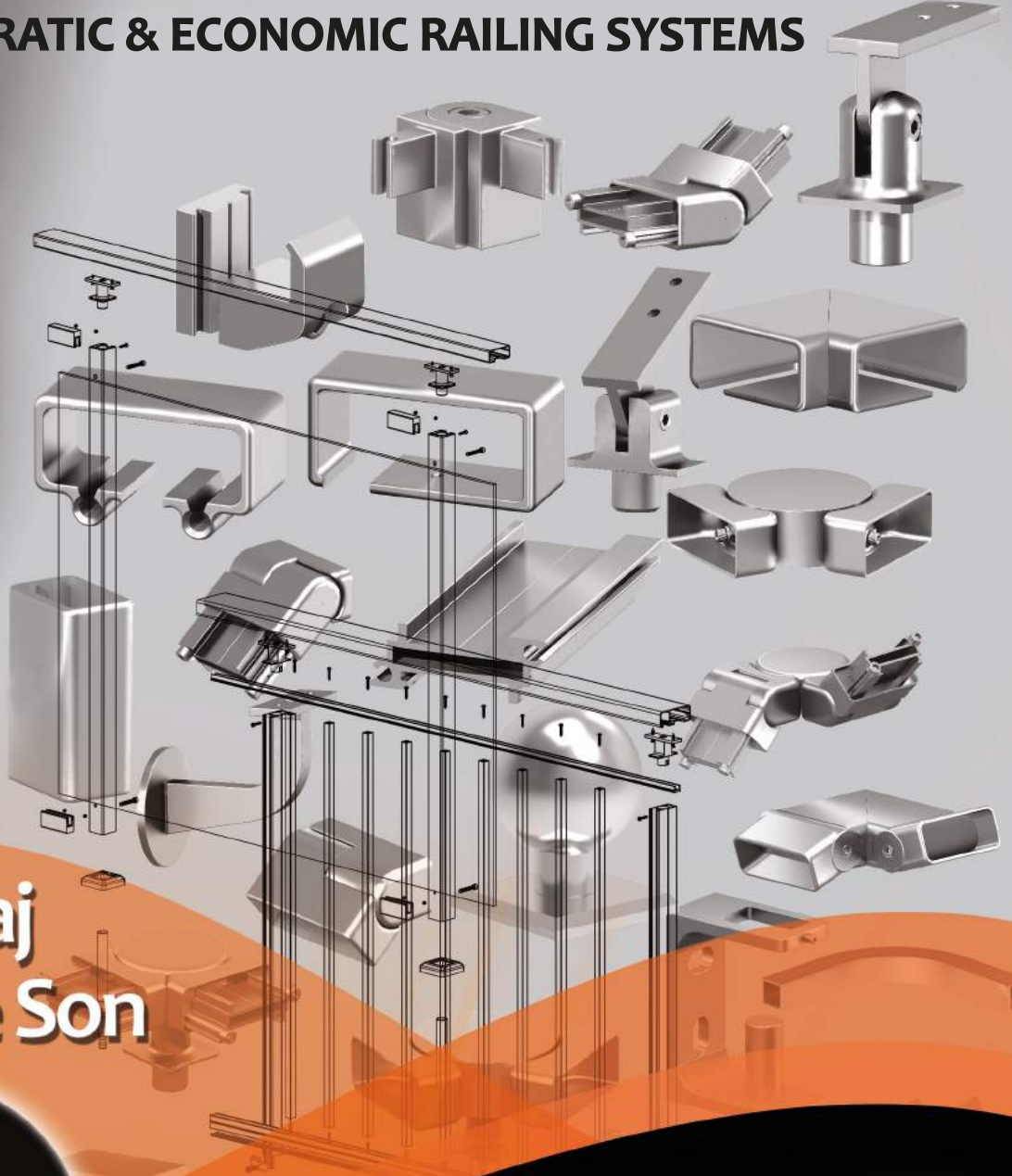

Ankraj
Delmeye Son

2017

No More
Anchor Drilling

Ürün Kataloğu
Product Catalogue

ecorail®

KORKULUK SİSTEMLERİ / RAILING SYSTEMS

İÇİNDEKİLER / INDEX

PROFİLLER PROFILES	1	TAPALAR ENDCAPS	6	FLANŞLAR FLANGES	9
UYGULAMALAR 1 APPLICATIONS 1	3	CAM TUTUCULAR GLASSHOLDERS	6	DİRSEKLER ELBOWS	10
MAFSALLAR SADDLES	4	UYGULAMALAR 3 APPLICATIONS 3	7	BAĞLANTI VE BİLEZİKLER JOINTERS & RINGS	12
UYGULAMALAR 2 APPLICATIONS 2	5	YAN BAĞLANTI PAPUÇLARI SIDE INSTALLATION BRACKETS	8	YARDIMCI MALZEMELER AUXILIARIES	13

KATALOG KULLANIMI HAKKINDA / ABOUT USAGE OF CATALOGUE

Ürün görsellerinin üst ve alt köşelerinde çeşitli ifadeler yer almaktadır. Aşağıdaki örneklere bu ifadelerin açıklamaları yapılmıştır.

ÖRNEK 1: [EM 211](#)

Üst köşede yer alan kodlar bu aksesuarımızın kullanılabileceği küpeşte profillerini, alt köşede yer alan kodlar ise dikme profillerini göstermektedir.

ÖRNEK 2: [ES 123C](#)

Üst köşede yer alan kodlar bu aksesuarımızın kullanılabileceği küpeşte profillerini, alt köşede yer alan ifadeler ise açılış imkanlarını göstermektedir.



There are various expressions on upper and bottom corners of images of product. These expressions are explained in the following examples.

EXAMPLE 1: [EM 211](#)

The codes at the upper corner show the balustrade profiles and the codes at the bottom corner show the post profiles with which this accessory can be used.

EXAMPLE 2: [ES 123C](#)

The codes at the upper corner show the balustrade profiles which can be used with this accessory and the angles at the bottom corner defines the angle abilities of this accessory.

Geliştirdiğimiz tüm ürünler tasarım tescil ve faydalı model belgeleri ile koruma altındadır. Ürünlerimizden ve katalogta bulunan görsellerimizden alıntı yapıldığı takdirde şirketimizce maddi ve manevi tazminat davasına konu edileceğini bilgilerinize sunarız.

Anlayış ve işbirliğiniz için teşekkür ederiz.

All of the profiles and accessories developed by our company are patented. Please note that pictures and drawings in this catalogue can not be used without our permission.

GÜRSAN ALÜMİNYUM bildirmeksizin değişiklik yapma hakkını saklı tutar. We reserve the right to change the specifications without notice.

ecorail®

KORKULUK SİSTEMLERİ / RAILING SYSTEMS

... bir **GÜRSAN ALÜMİNYUM** markasıdır.
... is a trademark of **GÜRSAN ALUMINIUM**

KÜPEŞTE PROFİLLERİ / HANDRAIL PROFILES

EP 111

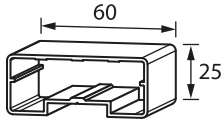

0.780 kg/mt

EP 112

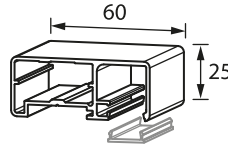

0.850 kg/mt

EP 113

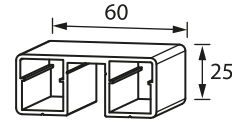

1.060 kg/mt

EP 121

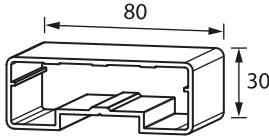

1.310 kg/mt

EP 122

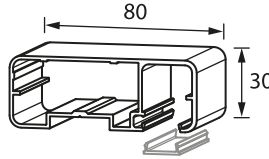

1.110 kg/mt

EP 123

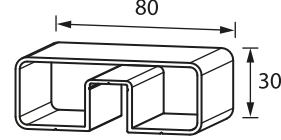

1.230 kg/mt

DİKME PROFİLLERİ / POST PROFILES

EP 201

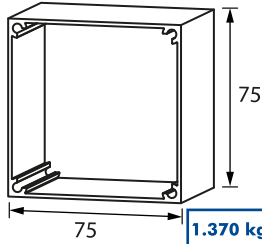

1.370 kg/mt

EP 211

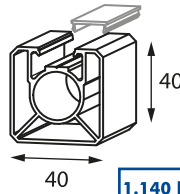

1.140 kg/mt

EP 212

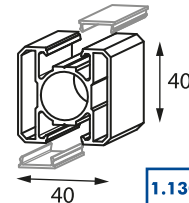

1.130 kg/mt

EP 213

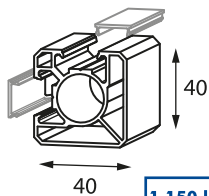

1.150 kg/mt

EP 221

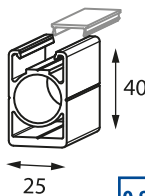

0.900 kg/mt

EP 231

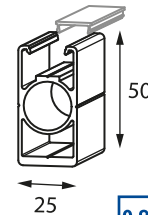

0.990 kg/mt

PANEL PROFİLLERİ / PANEL PROFILES

EP 311

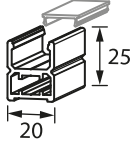

0.470 kg/mt

EP 311.120

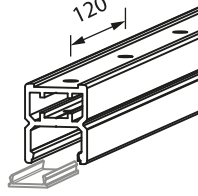

EP 321

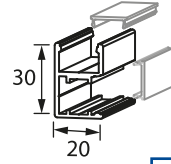

0.440 kg/mt

EP 331

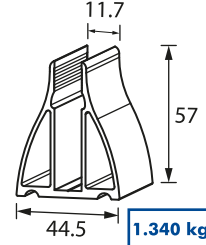

1.340 kg/mt

YATAY VE DÜŞEY EMNİYET PROFİLLERİ / HORIZONTAL & VERTICAL INFILL PROFILES

EP 411

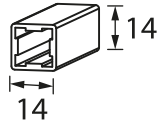

0.215 kg/mt

EP 412

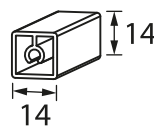

0.220 kg/mt

EP 422

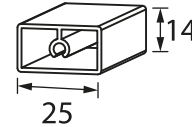

0.300 kg/mt

KAPAK PROFİLLERİ / CLOSER PROFILES

EP 001

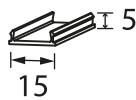

0.062 kg/mt

EP 002

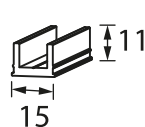

0.220 kg/mt

EP 002.120

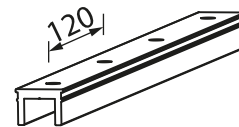

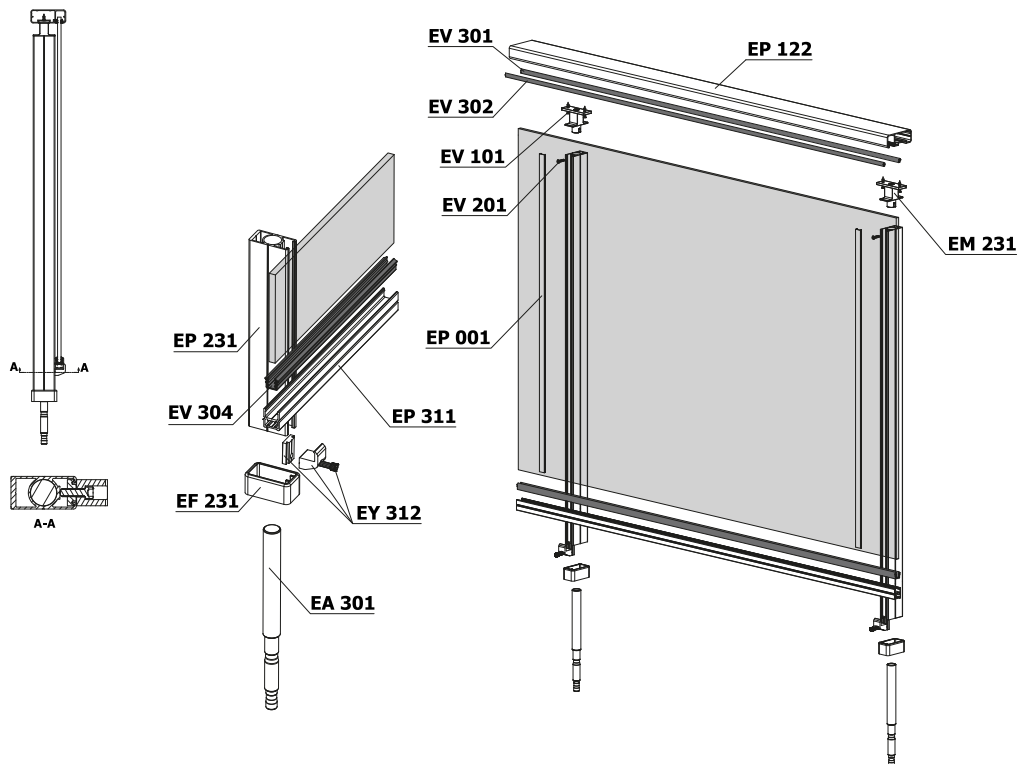
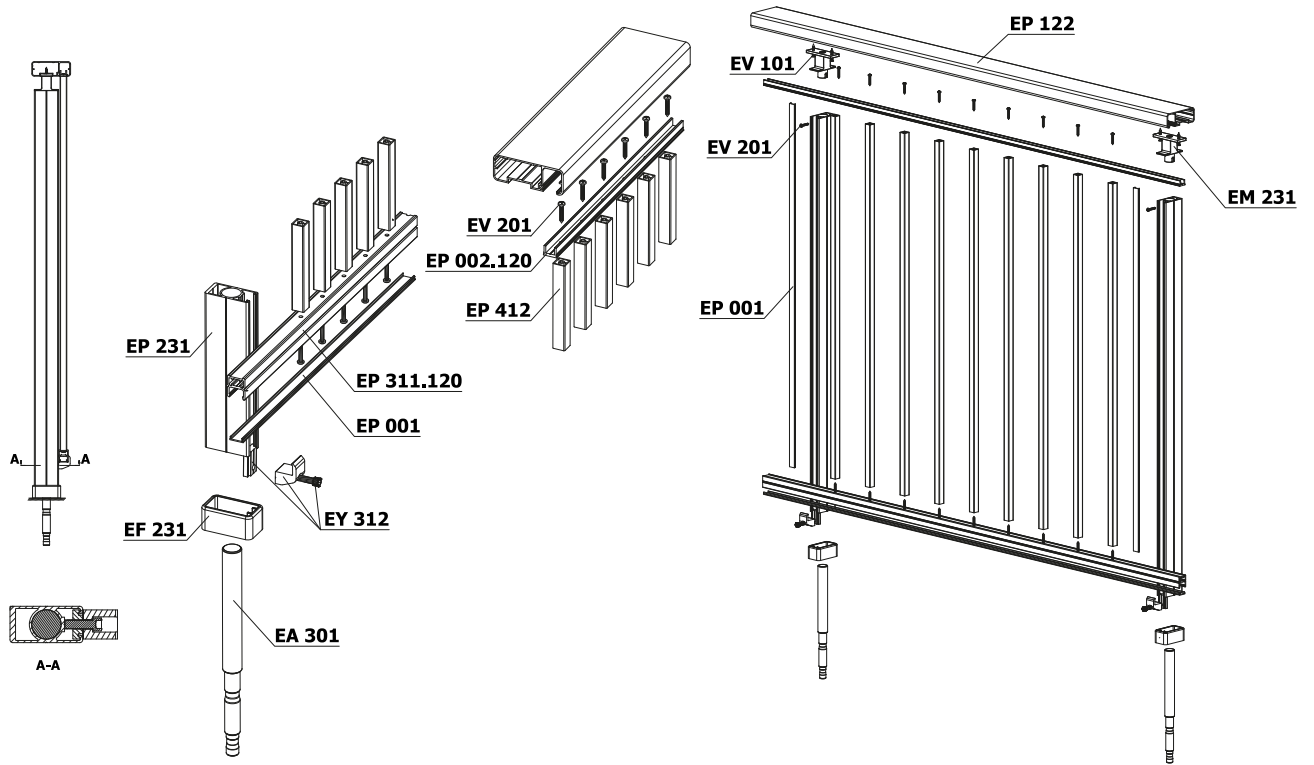

EM 111

EP 111
EP 121



EM 112

EP 111
EP 121



EM 211

EP 111
EP 112
EP 121
EP 122



EP 211
EP 212
EP 213

EM 212

EP 111
EP 121



EP 211
EP 212
EP 213

EM 213

EP 111
EP 121



EP 211
EP 212
EP 213

EM 214

EP 111
EP 112



EP 211
EP 212
EP 213

EM 214A

EP 111



EP 211
EP 212
EP 213

EM 215

EP 121
EP 122



EP 211
EP 212
EP 213

EM 215A

EP 121
EP 122



EP 211
EP 212
EP 213

EM 221

EP 111
EP 112
EP 121
EP 122



EP 221

EM 222

EP 111
EP 121



EP 221

EM 231

EP 111
EP 112
EP 121
EP 122



EP 231

EM 232

EP 111
EP 121



EP 231

EM 233

EP 113
EP 123



EP 231

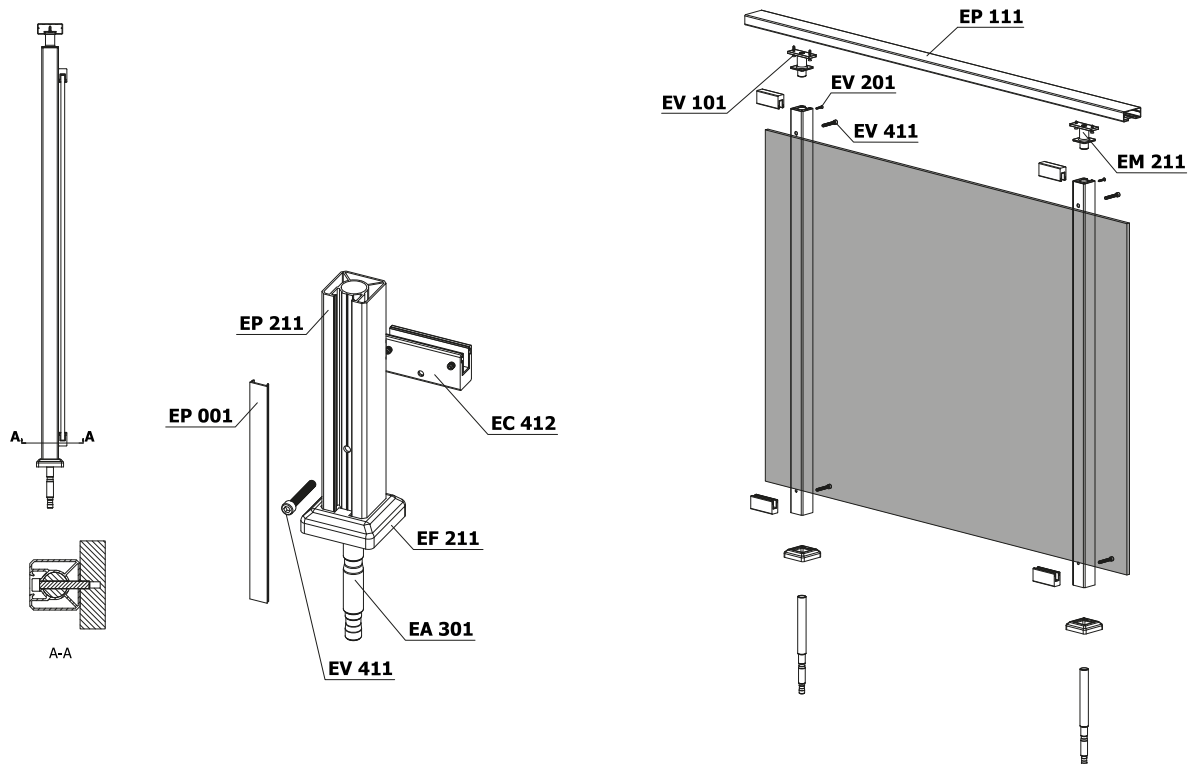
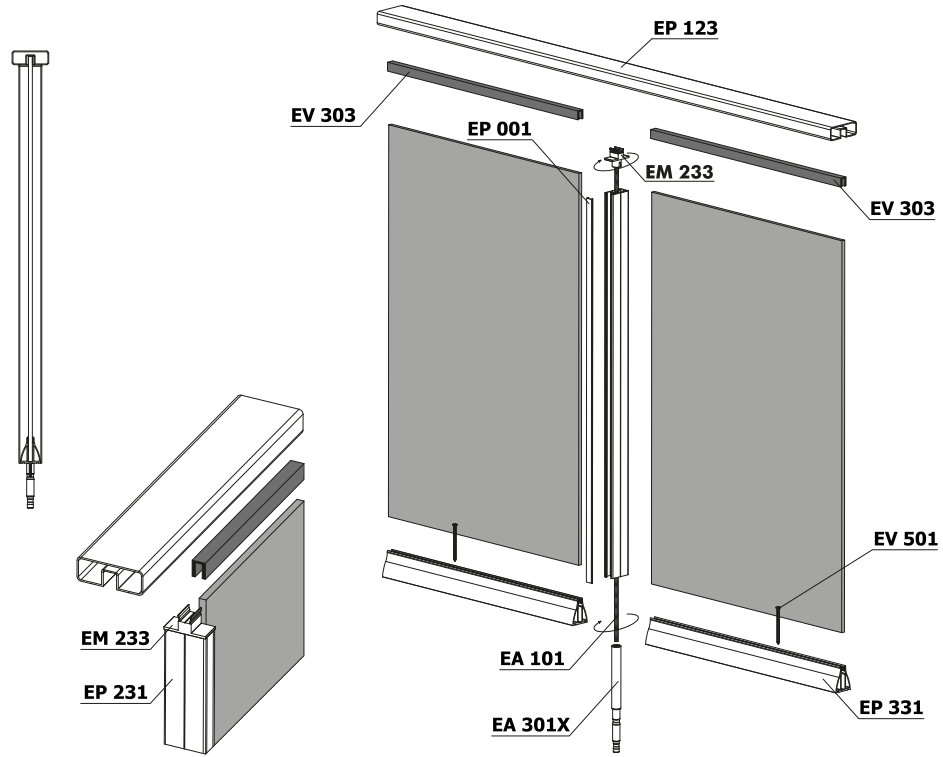

TAPALAR / ENDCAPS

ET 111

EP 111
EP 112



ET 113

EP 113



ET 121

EP 121
EP 122
EP 123



ET 201



EP 201

ET 211



EP 211
EP 212
EP 213

ET 221



EP 221

ET 231



EP 231

ET 311



EP 311

ET 321



EP 321

ET 411



EP 411

CAM TUTUCULAR / GLASSHOLDERS

EC 411A



EP 211
EP 212
EP 213

EC 411B



EP 211
EP 212
EP 213

EC 412



EP 211
EP 212
EP 213
EP 221
EP 231

EC 413



EP 211
EP 212
EP 213
EP 221
EP 231

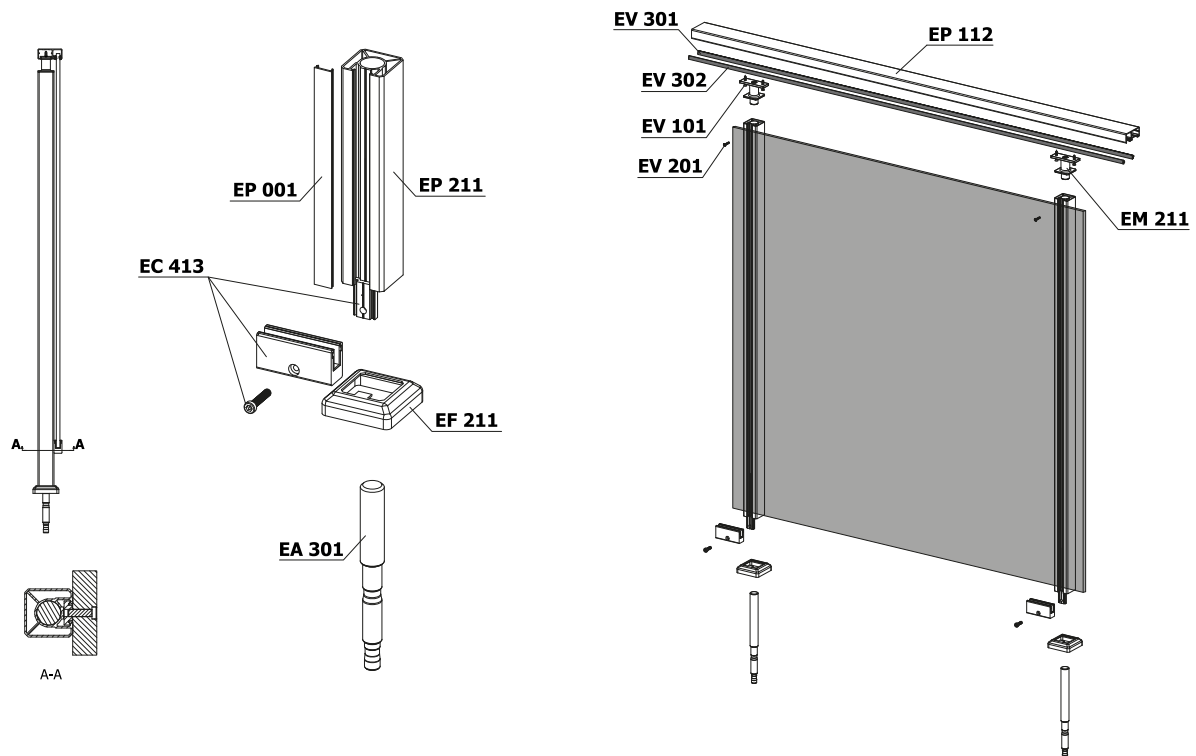
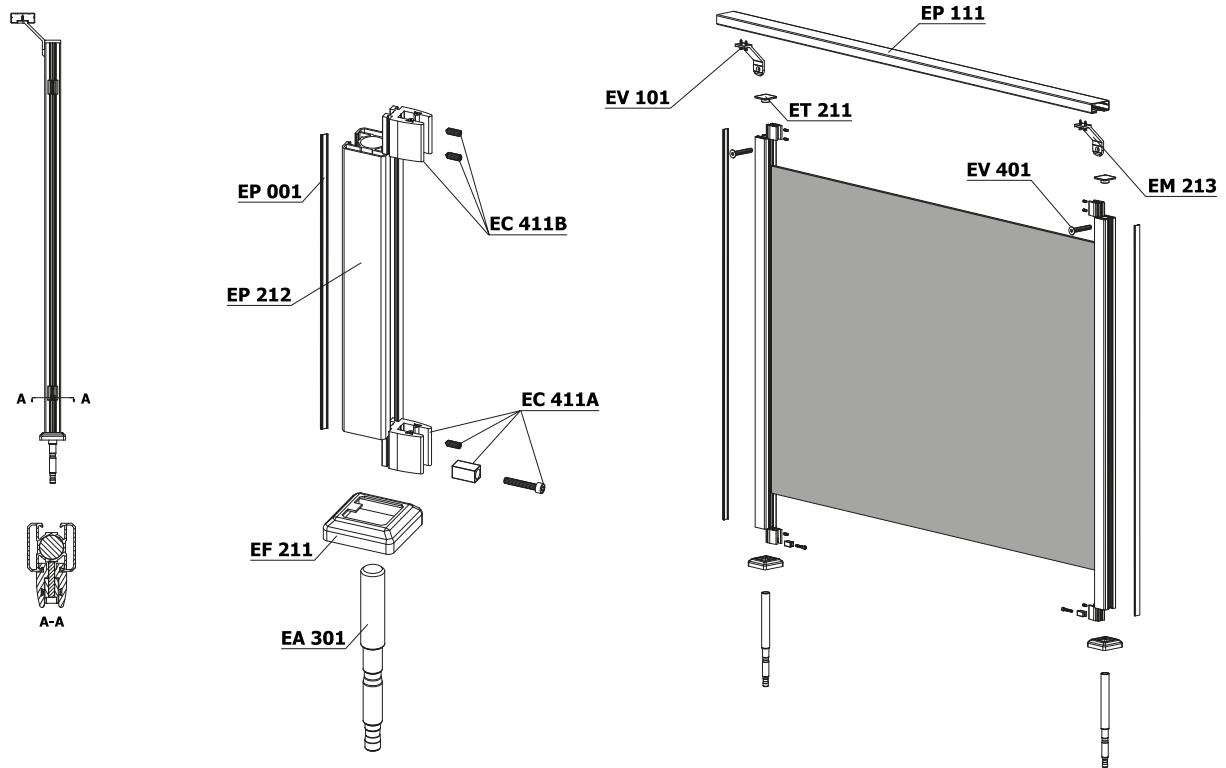

EY 211

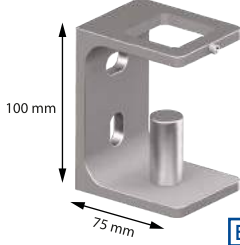

EP 211
EP 212
EP 213

EY 211A

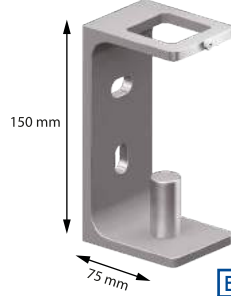

EP 211
EP 212
EP 213

EY 211B

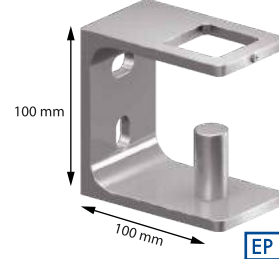

EP 211
EP 212
EP 213

EY 221

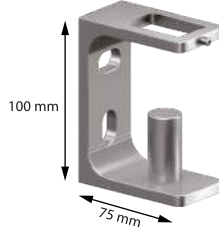

EP 221

EY 221A



EP 221

EY 221B

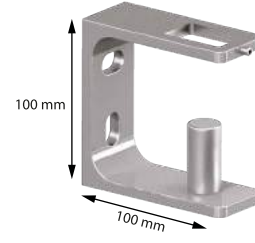

EP 221

EY 231



EP 231

EY 231A



EP 231

EY 231B

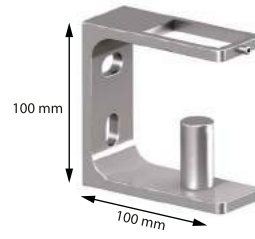

EP 231

EY 311

EP 311



EP 211
EP 212
EP 213
EP 221
EP 231

EY 312

EP 311



EP 211
EP 212
EP 213
EP 221
EP 231

EY 411

EP 411



EP 211
EP 212
EP 213
EP 221
EP 231

EF 111

EP 111
EP 112
EP 113



EF 112

EP 111



0-40°

EF 113

EP 113



EF 121

EP 121
EP 122
EP 123



EF 122

EP 121



0-40°

EF 123

EP 123



EF 201



EP 201

EF 201A



EP 201

EF 211



EP 211
EP 212
EP 213

EF 211A



EP 211
EP 212
EP 213

EF 212



EP 211
EP 212
EP 213

EF 221



EP 221

EF 222



EP 221

EF 231



EP 231

EF 232



EP 231

ES 111

EP 111
EP 112



90°

ES 111A

EP 113

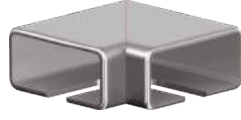

90°

ES 111B

EP 112



90°

ES 111C

EP 112



90°

ES 112

EP 111
EP 112



45°

ES 112A

EP 113

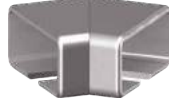

45°

ES 112B

EP 112

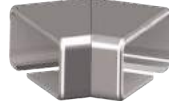

45°

ES 112C

EP 112



45°

ES 113

EP 111



0-90°

ES 113A

EP 111



0-40°

ES 113B

EP 111



0-90°+0-40°

ES 113C

EP 111



0-40°+0-90°+0-40°

ES 121

EP 121
EP 122



90°

ES 121A

EP 123



90°

ES 121B

EP 122



90°

ES 121C

EP 122

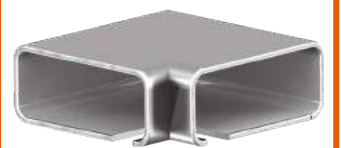

90°

ES 122

EP 121
EP 122

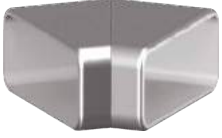

45°

ES 122A

EP 123

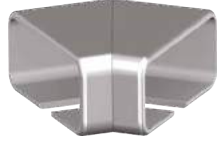

45°

ES 122B

EP 122

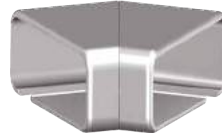

45°

ES 122C

EP 122



45°

ES 123

EP 121
EP 122



0-90°

ES 123A

EP 121



0-40°

ES 123BL

EP 121



90+0-40°

ES 123BR

EP 121



0-40°+90°

ES 123C

EP 121



0-40°+90°+0-40°

ES 311

EP 311



0-90°

ES 321

EP 321



0-90°

ES 411

EP 411



90°

ES 412

EP 411



45°

ES 412A

EP 411



30°

ES 413

EP 411



0-90°

ES 413A

EP 411



90°+0-90°

EB 111

EP 111
EP 112



EB 111A

EP 113



EB 111B

EP 112



EB 112

EP 111



EB 113

EP 111
EP 112
EP 121
EP 122



EB 121

EP 121
EP 122



EB 121A

EP 123



EB 121B

EP 122



EB 312

EP 311



EB 322

EP 321



EB 411

EP 411



EB 412

EP 411



FİTİLLER / GASKETS



VIDALAR VE YAPIŞTIRICILAR / SCREWS AND GLUES

VIDALAR / SECREWS		
	EV 101	YHB 4,2x19
	EV 102	YHB 4,2x38
	EV 103	YHB 4,2x45
	EV 201	YSB 4,2X19
	EV 202	YSB 4,2X25
	EV 203	YSB 4.2X38
	EV 204	YSB 4.2X45

PASLANMAZ İMBUS CIVATALAR HEXAGONAL SOCKET SCREWS		
	EV 401	M6x40
	EV 411	M6x40
	EV 412	M6x45
	EV 413	M6x50

BULDEKS VİDA / BULDEX SCREW		
	EV 501	7,5x100



ANKRAJLAR / ANCHORS



SAPLAMALAR / RODS	
EA 101	M8x140
EA 102	M8x1000
EA 103	M10x1250
EA 104	M10x150

ANKRAJLAR / ANCHORS		
KOD CODE	Ø (mm)	L (mm)
EA 301	20	350
EA 301X*	20	350
EA 301A	20	230
EA 301B	20	200
EA 301D	20	140
EA 301E**	20	220

*Üst kısım M8 dişli
*With M8 thread on top
**Borudan mamüldür
**Produced from pipe

SOMUNLAR / NUTS		
	EA 201	M8 Somun M8 Nut
	EA 202	M10 Somun M10 Nut
	EA 206	M10 Kör Somun M10 Blind Nut

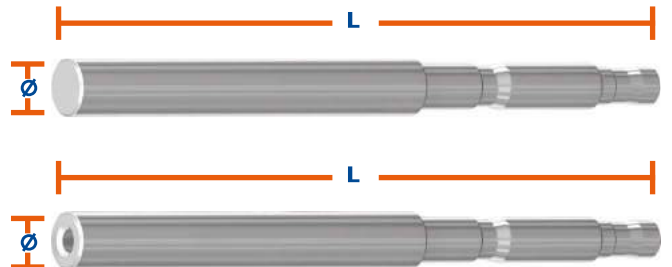

ecorail®

KORKULUK SİSTEMLERİ / RAILING SYSTEMS

 **GÜRSAN®**
ALÜMİNYUM İMALAT SANAYİ LTD. ŞTİ.

ALKOP San. Sit. B-7 Blok No:15 Esenyurt / İstanbul / Türkiye
Tel: +90 212 858 01 61 Fax: +90 212 858 01 65
www.gursan.com.tr www.alurail.com.tr
satis@gursan.com.tr
export@gursan.com.tr

ANADOLU YAKASI
SATIŞ VE UYGULAMA BAYİ

Yapı Sistemleri San. Tic. Ltd. Şti.

Yedpa Ticaret Merkezi Mimar Sinan Mah. Üsküdar Cad.
No:1 Kat: H1 No:129 Ataşehir / İstanbul
Tel: 0216 365 14 68 Faks: 0216 365 14 69
info@sisaluminyum.com